



CENTURION LEISURE

# ENDLESS POOLS

Endless Pools provide all the benefits of traditional swimming pools, in a fraction of the space.

D E S I G N | C O N S T R U C T I O N | I N N O V A T I O N

Imagine your own private swimming pool, installed just steps away, set to the temperature you desire, with less chlorine than drinking water -- a pool that can be installed virtually anywhere, indoors or out and used year-round for lap swimming, aqua aerobics, hydrotherapy and family fun.

“WE ABSOLUTELY LOVE OUR  
ENDLESS POOL. IT GIVES US  
GREAT EXERCISE OPPORTUNITIES.  
THE WHOLE FAMILY GET TO  
ENJOY IT AND GET FIT AT THE  
SAME TIME!”

Introducing, the Endless Pool, the intelligently designed swimming pool for today's world. The Endless Pool is the small pool with BIG benefits! Since 1988, tens of thousands of customers worldwide have realised the benefits of daily aquatic exercise, in the privacy and convenience of their own homes, now it's your turn.



Endless Pools are ideal for:

- SWIMMING & AQUA AEROBICS
- HYDROTHERAPY
- TRIATHLON TRAINING
- FAMILY FUN
- PURE ENJOYMENT

CENTURION LEISURE are proud to be Endless Pools premiere pool dealer for your area.

As traditional pool builders with over 50 years experience Endless Pools' recognised that as a company we are perfectly positioned to deliver the level of build quality, technical expertise and after sales care that they demand worldwide from their preferred dealerships.



Double Olympic Gold medalist, Alistair Brownlee using an Endless Pools aquatic cross trainer.



Within this brochure you will find our four main product groups. The pool that started it all, **The Classic**, the perfect swim exercise pool for almost all households. **The Challenger** is the upgrade pool for those that prefer a more vigorous exercise regime in their lives. **The Cross Trainer** is ideal way to enjoy your daily run within the confines of your own pool. This is particularly good for recovery work as there is much less impact on muscles and tendons etc. whilst running in water and therefore leads to less muscle soreness and quicker recovery and rehabilitation.

Finally, for more commercial purposes we have **The Elite**, a counter-current swimming machine that revolutionises swim instruction. The Elite offers a unique opportunity to analyse every element of their swimmers' stroke, while providing both coach and athlete instantaneous, real-time feedback via multiple adjustable cameras and mirrors. Most importantly, the Elite is fast, strong and smooth.





# ENDLESS POOLS - CLASSIC PACKAGE

All the benefits of traditional swimming pools in a fraction of the space.

The first Original Endless Pool swimming machine was installed in 1988. It made in-place swimming not only possible, but pleasurable and convenient. Since then, we've evolved that design into what you can own today: the best, most cost-efficient swimming machine on the market.

## MODEL

Original Endless Pool: Single Propeller,  
5Hp System. 1:14/100m Top Speed: Swim pace



## ACCESSORIES INCLUDED

- |                            |                          |
|----------------------------|--------------------------|
| 1. Synthetic Coping        | 5. Underwater LED Lights |
| 2. Manual Safety Cover     | 6. Swim Pace Display     |
| 3. Tensions Straps         | 7. Corner Step           |
| 4. Fit@Home Controller App | 8. Swim Mirror           |

## SIZE, SPACE AND ELECTRICAL

Interior (Swim) Dimensions:  
2130mm X 4270mm & ' x 14')

Exterior Dimensions:

2600mm X 5190mm X 1110mm

Water Depth: 990mm (39")

Water Volume: 9,740 Litres

Electrical (Single Phase):

50Hz = 1 x 230V, 32 Amp

RCD Power Supply

\*Call For 3 Phase Electrical Requirements

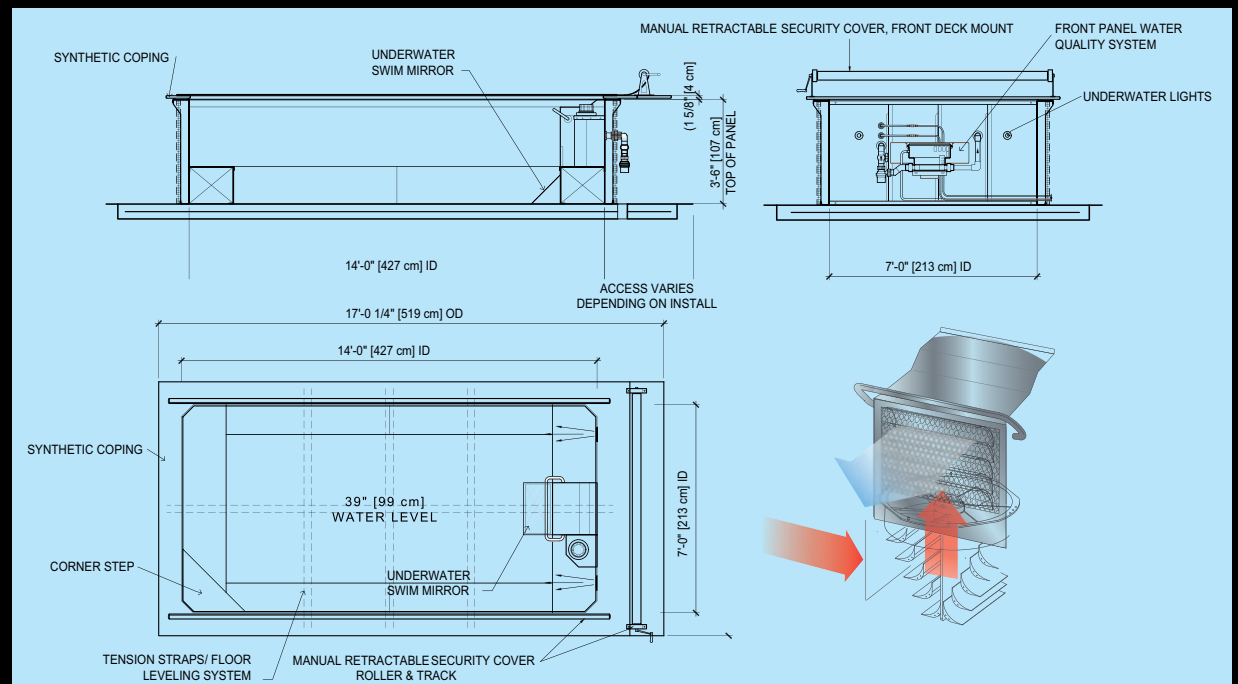

# ENDLESS POOLS - CLASSIC PACKAGE CHOICES



## LINER CHOICES

We offer a wide range of pool liners from simple and straightforward colours, to attractive traditional mosaics



Dark Blue



Light Blue

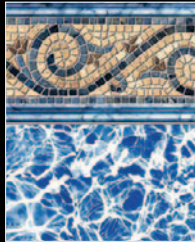

Siesta Wave Tan

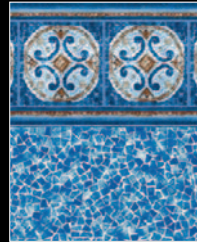

Hampton

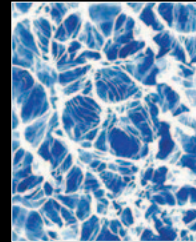

Diffusion



Seaglass

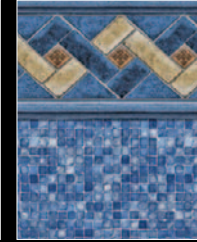

Mountain Top



Ancient Seas

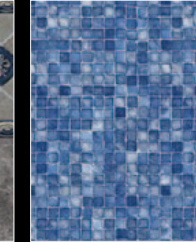

Blue Mosaic

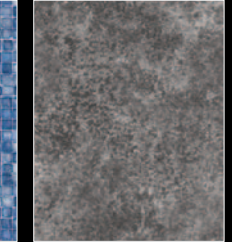

Grey Marino

## COPING CHOICES



Moonlight Granite



Frost Granite



Platinum

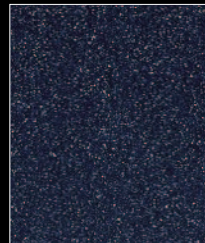

Sapphire

## SECURITY COVER COLOUR CHOICES

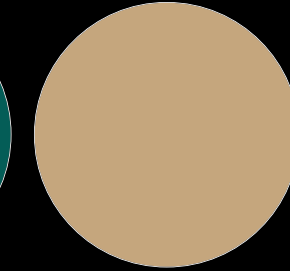
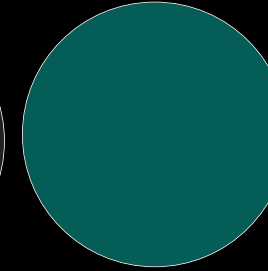
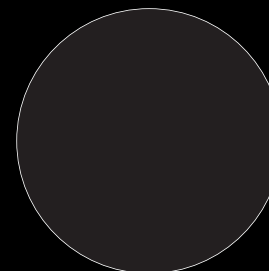
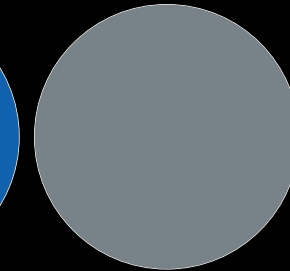
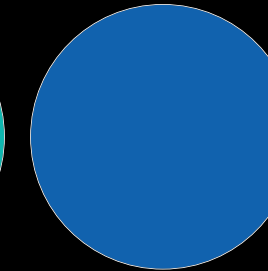
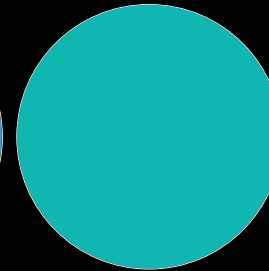
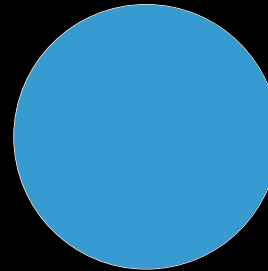

Images and colours are shown for guidance and may differ from actual items. If in doubt, it is always recommended to make your selection from one of our swatches.

# ENDLESS POOLS - CHALLENGER PACKAGE

The Challenger custom-designed two-propeller system delivers a superior swim from its larger swim outlet grille. It's faster (or not). Power it up to its demanding top speed of 1:11/100m, or at the push of a button, slow the current down to a gentle pace. It's smoother. Many swimmers even call it "soft." We can get technical about the propellers' counter-rotation, but it all comes down to this – the current just feels better!

## MODEL

Performance Endless Pool: Two Propellers, 5 Hp, system. 1:11/100m Top Speed. Larger swim outlet grill than the Original – Wider, Deeper, Smoother.



## ACCESSORIES INCLUDED

1. Synthetic Coping
2. Manual Safety Cover
3. Tensions Straps
4. Fit@Home Controller App
5. Underwater LED Lights
6. Swim Pace Display
7. Corner Step
8. Swim Mirror
9. Bench Riser (6 Inch)

## SIZE, SPACE AND ELECTRICAL

Interior (Swim) Dimensions:

2130mm X 4270mm (7' x 14')

Exterior Dimensions:

2600mm X 5190mm X 1260mm

Water Depth: 1140mm (45")

Water Volume: 11,129 Litres

Electrical (Single Phase):

50Hz = 1 x 230V, 32 Amp

RCD Power Supply

\*Call For 3 Phase Electrical Requirements

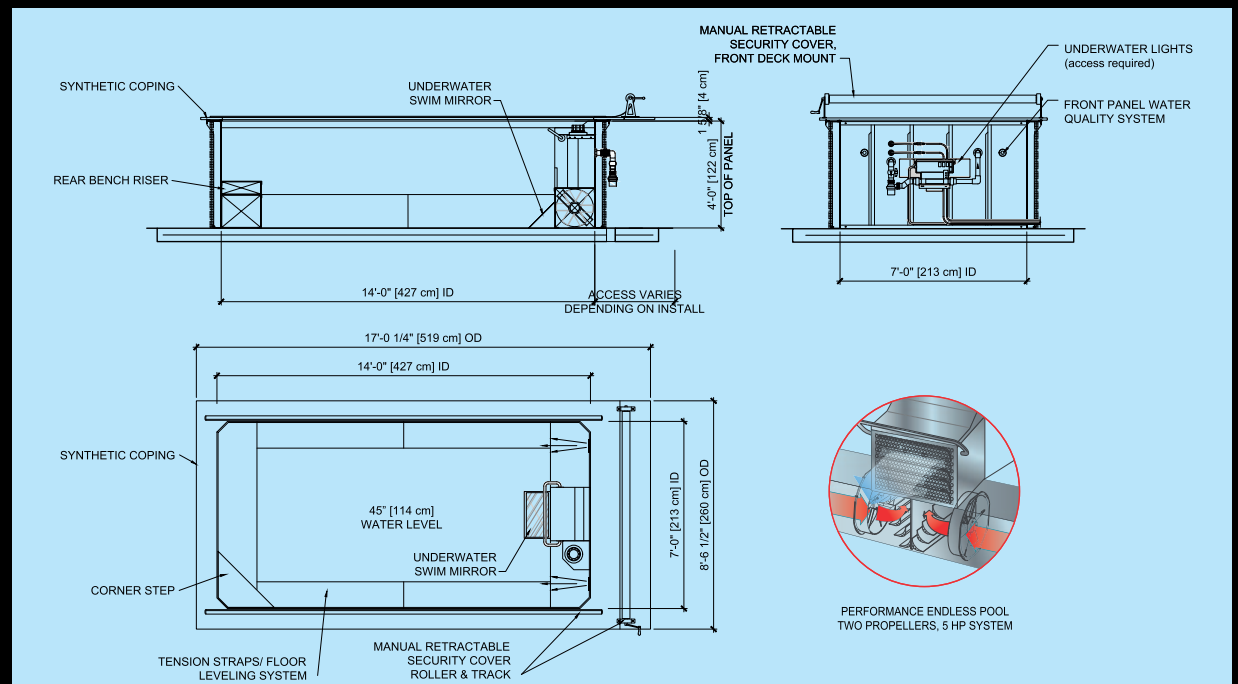



# ENDLESS POOLS - CHALLENGER PACKAGE CHOICES



## LINER CHOICES

We offer a wide range of pool liners from simple and straightforward colours, to attractive traditional mosaics



Dark Blue



Light Blue

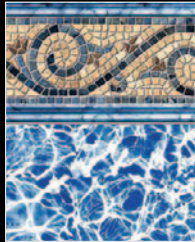

Siesta Wave Tan



Hampton

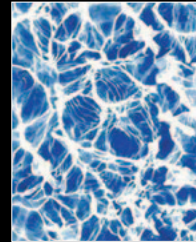

Diffusion

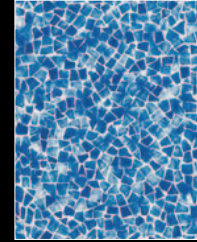

Seaglass

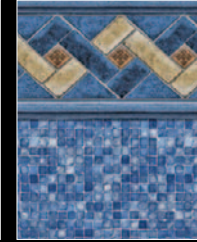

Mountain Top



Ancient Seas

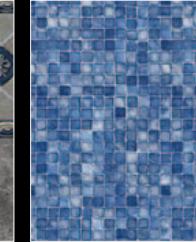

Blue Mosaic

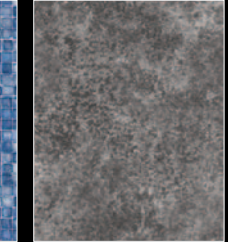

Grey Marino

## COPING CHOICES



Moonlight Granite



Frost Granite

## RETURN CHANNEL CHOICES



Platinum

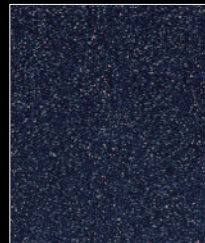

Sapphire

## SECURITY COVER COLOUR CHOICES

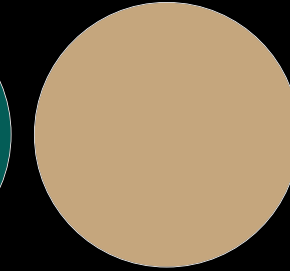
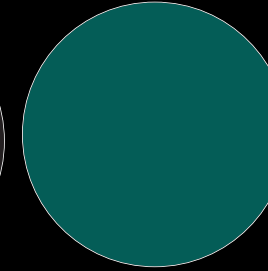
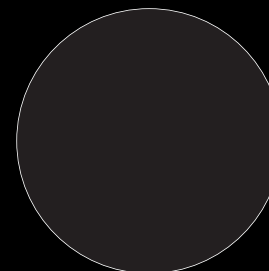
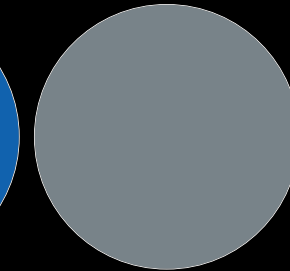
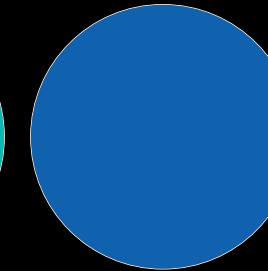
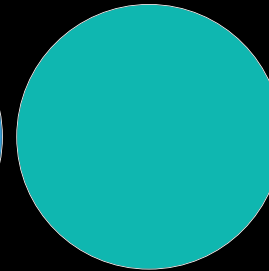
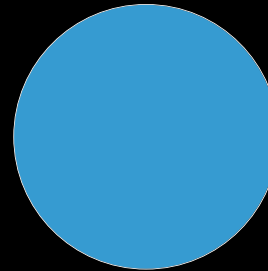

Images and colours are shown for guidance and may differ from actual items. If in doubt, it is always recommended to make your selection from one of our swatches.

# ENDLESS POOLS - CROSS TRAINER PACKAGE

Walk, jog, or run on our underwater treadmill, and you'll burn as many calories as on a dry-land treadmill. You'll also enjoy:

- An increased range of motion
- Less muscle soreness (perfect for recovery runs)
- Minimal joint impact (no dry-land pounding!)
- All-direction resistance for a more thorough workout

## MODEL

Performance Endless Pool: Two Propellers, 5 Hp, system. 1:11/100M  
 Top Speed : Swim pace. Larger swim outletgrill than the original – Wider, Deeper, Smoother



## ACCESSORIES INCLUDED

- |                            |                            |
|----------------------------|----------------------------|
| 1. Synthetic Coping        | 7. Corner Step             |
| 2. Manual Safety Cover     | 8. Swim Mirror             |
| 3. Tensions Straps         | 9. Bench Riser (12 Inch)   |
| 4. Fit@Home Controller App | 10. Floor Mirror           |
| 5. Underwater LED Lights   | 11. Underwater Treadmill   |
| 6. Swim Pace Display       | 12. Treadmill Pace Display |

## SIZE, SPACE AND ELECTRICAL

Interior (Swim) Dimensions:

2130mm X 4270mm (7' x 14')

Exterior Dimensions:

2600mm X 5190mm X 1410mm

Water Depth: 1300mm (51")

Water Volume: 12,522 Litres

Electrical (Single Phase):

50Hz = 2 x 230V, 32 Amp

RCD Power Supply

\*Call For 3 Phase Electrical Requirements

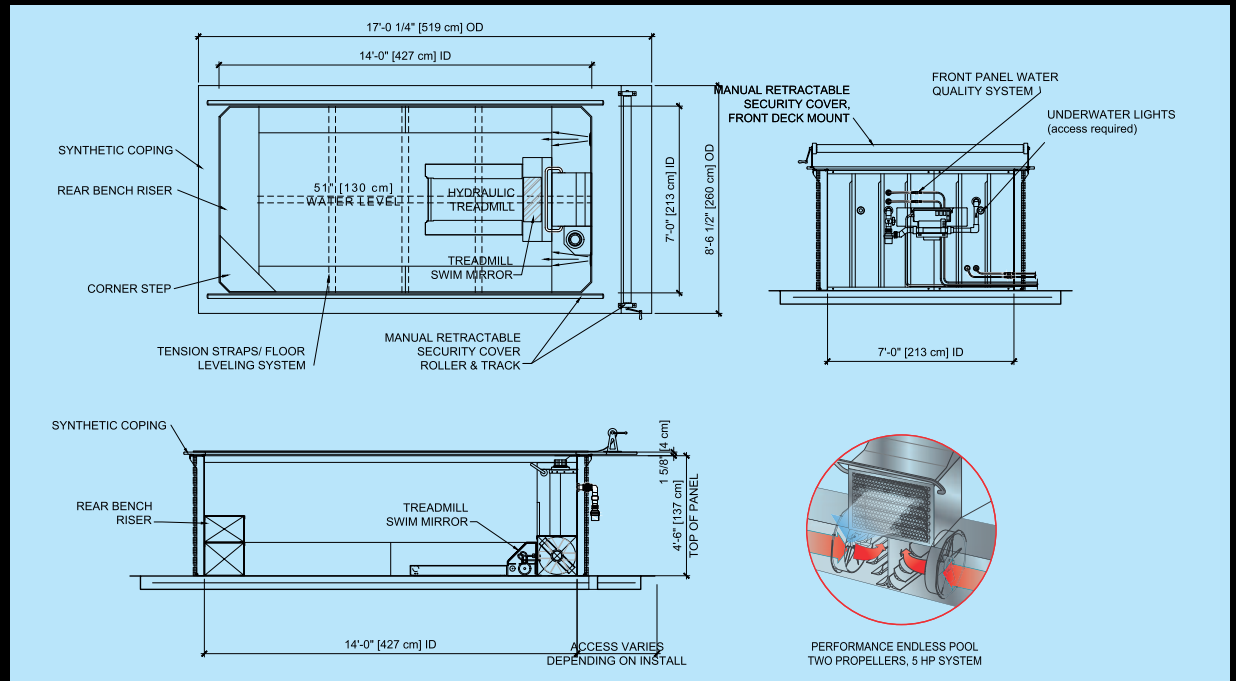



# ENDLESS POOLS - CROSS TRAINER PACKAGE CHOICES



## LINER CHOICES

We offer a wide range of pool liners from simple and straightforward colours, to attractive traditional mosaics



Dark Blue



Light Blue

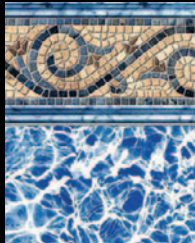

Siesta Wave Tan

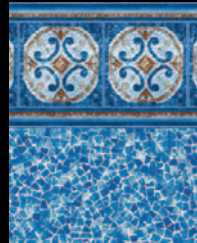

Hampton

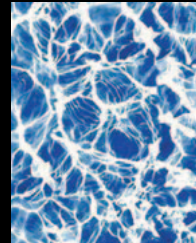

Diffusion



Seaglass

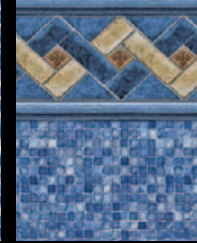

Mountain Top



Ancient Seas

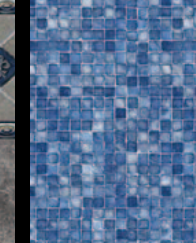

Blue Mosaic

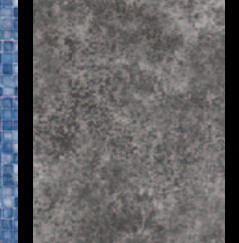

Grey Marino

## COPING CHOICES



Moonlight Granite



Frost Granite

## RETURN CHANNEL CHOICES



Platinum

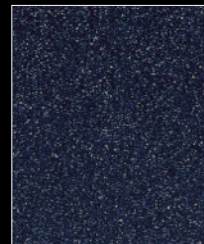

Sapphire

## SECURITY COVER COLOUR CHOICES

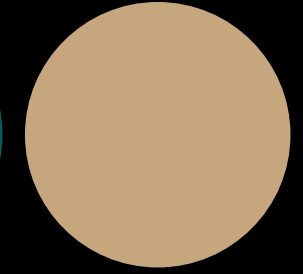
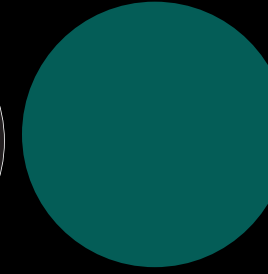
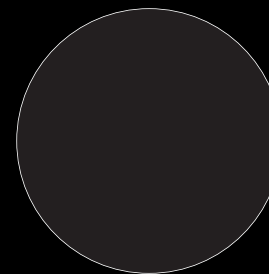
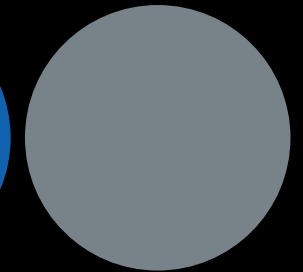
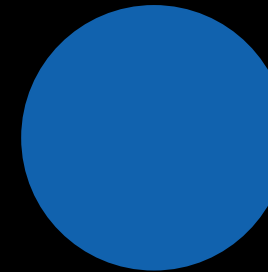
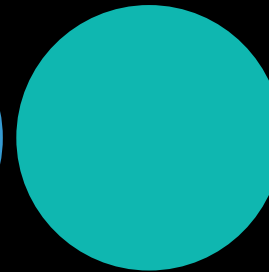
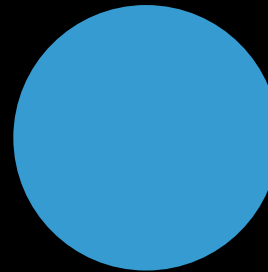

Images and colours are shown for guidance and may differ from actual items. If in doubt, it is always recommended to make your selection from one of our swatches.

# ENDLESS POOLS - ELITE POOL PACKAGE

For the highest caliber swimmers, our Endless Pools Elite offers the fastest, smoothest swim current available in any swimming machine. This pool is for the professional swimmer; at maximum power the Elite can reach 0.56 sec/100 metre pace, with two custom designed propellers operated by a single remote control, which challenges even the fastest swimmers.

## MODEL

Elite Endless Pool. 7.5hp system. The custom designed 24" x 18" outlet produces a flow of water that is wider, deeper and smoother than our standard system made possible by using two propellers.



## ACCESSORIES INCLUDED

1. Synthetic Coping
2. Manual Safety Cover
3. Tensions Straps
4. Fit@Home Controller App
5. Underwater LED Lights
6. Swim Pace Display
7. Corner Step
8. Swim Mirror

## SIZE, SPACE AND ELECTRICAL

Interior (Swim) Dimensions:

2440mm x 4270mm (8' x 14')

Exterior Dimensions

2850mm x 4670mm (9'4" x 15'4")

Water Depth: 114mm (45")

Volume: 11,877 litres

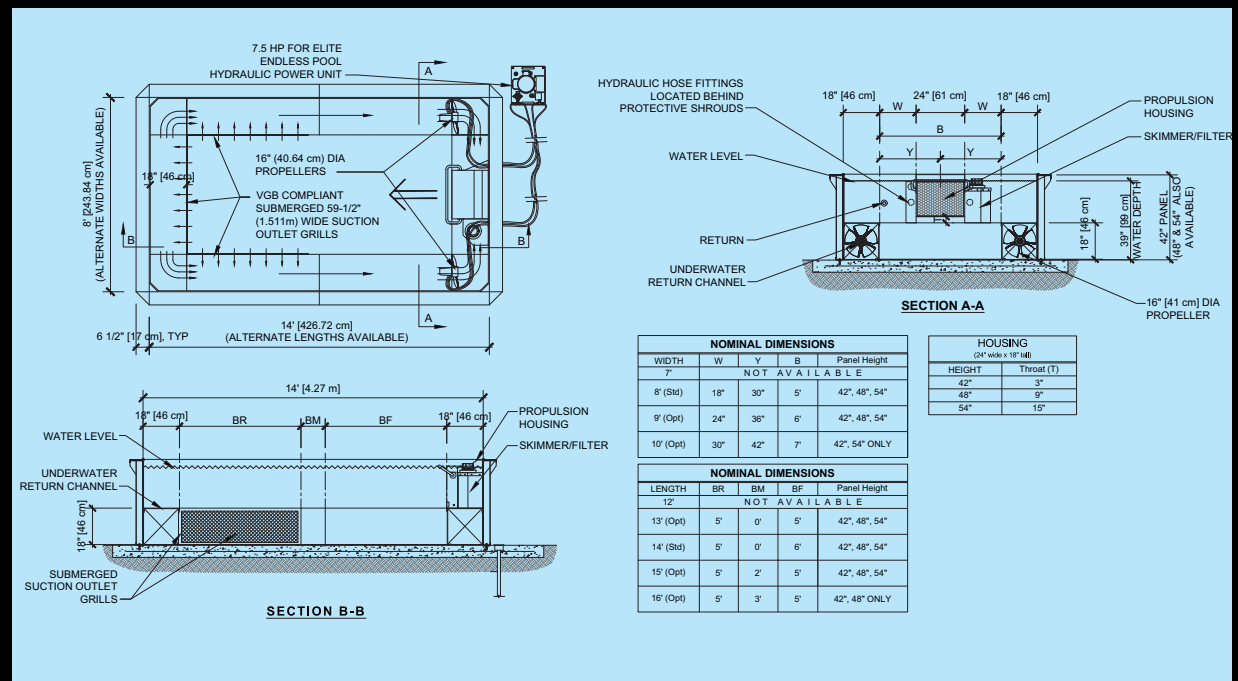



# ENDLESS POOLS - ELITE PACKAGE CHOICES



## LINER CHOICES

We offer a wide range of pool liners from simple and straightforward colours, to attractive traditional mosaics



Dark Blue



Light Blue

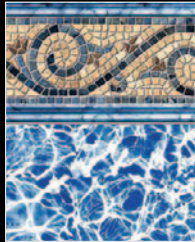

Siesta Wave Tan



Hampton

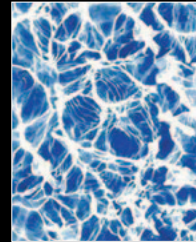

Diffusion

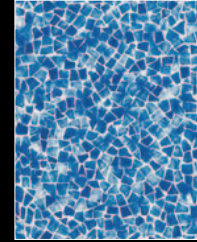

Seaglass

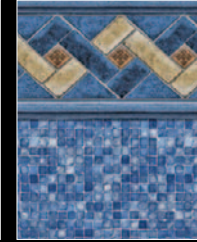

Mountain Top



Ancient Seas

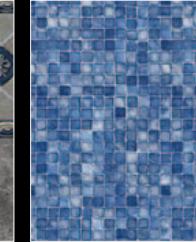

Blue Mosaic

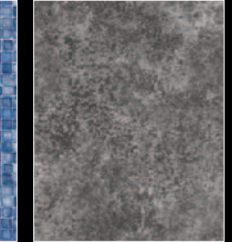

Grey Marino

## COPING CHOICES



Moonlight Granite



Frost Granite

## RETURN CHANNEL CHOICES

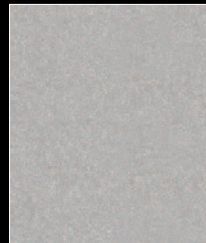

Platinum

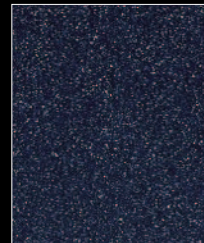

Sapphire

## SECURITY COVER COLOUR CHOICES

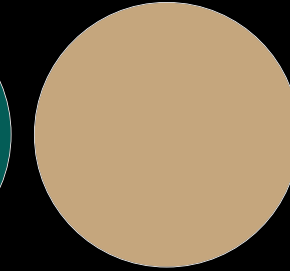
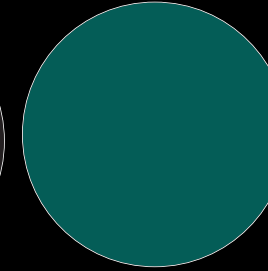
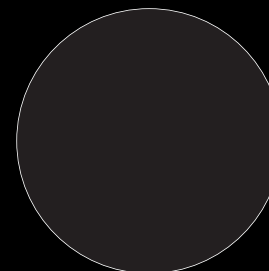
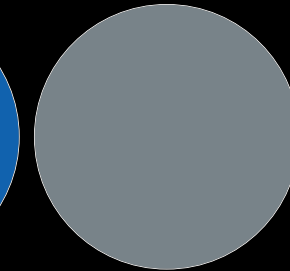
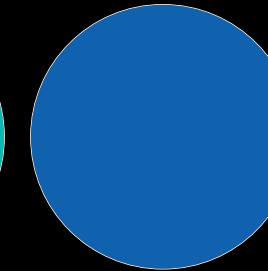
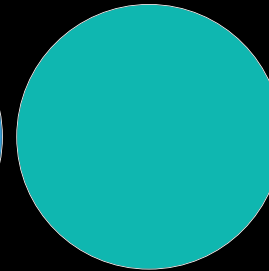
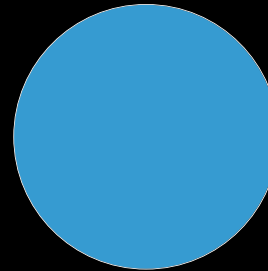

Images and colours are shown for guidance and may differ from actual items. If in doubt, it is always recommended to make your selection from one of our swatches.





D E S I G N | C O N S T R U C T I O N | I N N O V A T I O N

To turn your dreams into reality - contact us today for a free design consultation

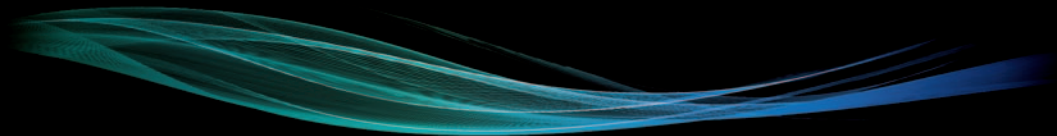

## CENTURION LEISURE

214 High Street, Hornchurch, Essex RM12 6QP

Call us on: 01708 463 090 or 01708 620 520

Email us at: [info@centurionleisure.co.uk](mailto:info@centurionleisure.co.uk)

[www.centurionleisure.co.uk](http://www.centurionleisure.co.uk)

