

CENTURION LEISURE

FULLY TILED ONE PIECE POOLS AND SPAS



D E S I G N | C O N S T R U C T I O N | I N N O V A T I O N



FULLY TILED ONE PIECE POOLS AND SPAS

From SPATA's National Pool Contractor of the Year 2024

Contents

About Us	04
What We Do	06
Why Choose GRP?	08
Drawings & Renders	10
Delivery & Installation	12
Warranty	13
Products	14
Swimming Pools	14
Freeboard/Skimmer Spas	16
Deck Level/Overflow Spas	18
Infinity Pools & Spas	20
Hydropools/Vitality Spas	22
SwimSpas	24
Plunge Pools	26
Balance Tanks	28
Control Panels	29
Additional Features	30
Tiles	32
Automatic Safety Covers	34
Automatic Slatted Pool Covers	36



About Us

Centurion Leisure are a company specializing in all aspects of spa, pool and wellness installations. We are a nationally recognised multi-award winning pool builder. So you can purchase from us with total confidence.

With our partners we fabricate all of our bespoke products from highly durable, quality materials, in a custom 12,000 sq ft factory in the North West of England. We produce feature-rich control units, placing us at the forefront of the pool, spa and wellness installations sector.



What We Do

Centurion Leisure and our partners are market leaders in the design and manufacture of fibreglass tiled pools and spas. Working from a 12,000 sq ft manufacturing facility in the North West of England.

All our products are manufactured uniquely to exacting requirements providing durability, teamed with aesthetical perfection. Our vast experience in every single aspect of your pool build means our products display professional craftsmanship and our installations technical perfection.



Why Choose GRP?

The benefits of choosing a fiberglass (GRP) tiled pool or spa can far outweigh the more traditional methods such as concrete due to speed of construction, reduced costs and greater access to all fittings, pipework and electrics.

Choosing GRP over concrete for the build of your pool or spa provides many benefits including; reduced cost, reduced installation time and increased speed of construction. GRP comes with the same warranties as concrete (this is an enhanced not inferior product to that of concrete), greater access to fittings so less downtime if any failures occur (key for commercial businesses), exacting programme dates as built in factory conditions not open air sites where weather can affect programme, high quality of finish with QMS control, pre-water testing prior to delivery so no onsite water / leakage issues and more bespoke creativity in design.

Products can be installed in as little as one day, ready for field pipe/plant connections. Once you have chosen your prefabricated, tiled pool or spa, there are an endless list of additions that can be included. WE offer an extensive range of additional features such as pool covers, water features, air and water jets, both white and colour changing lights (mini, midi and large) and much more.

600 x 150 x 20mm Top Edge Coping Stone

4mm Mosaic Tile with Chosen Epoxy Grout

3mm Two-part Epoxy Adhesive

2mm Gel Coat

3mm First Layer GRP

6mm Wall Coring Layer

4mm Structural Main Layer GRP

Foam Insulation Thickness to Suit Project Setup

50 x 50mm 304 Stainless Steel Adjustable Leg

8mm Structural Floor Coring Layer

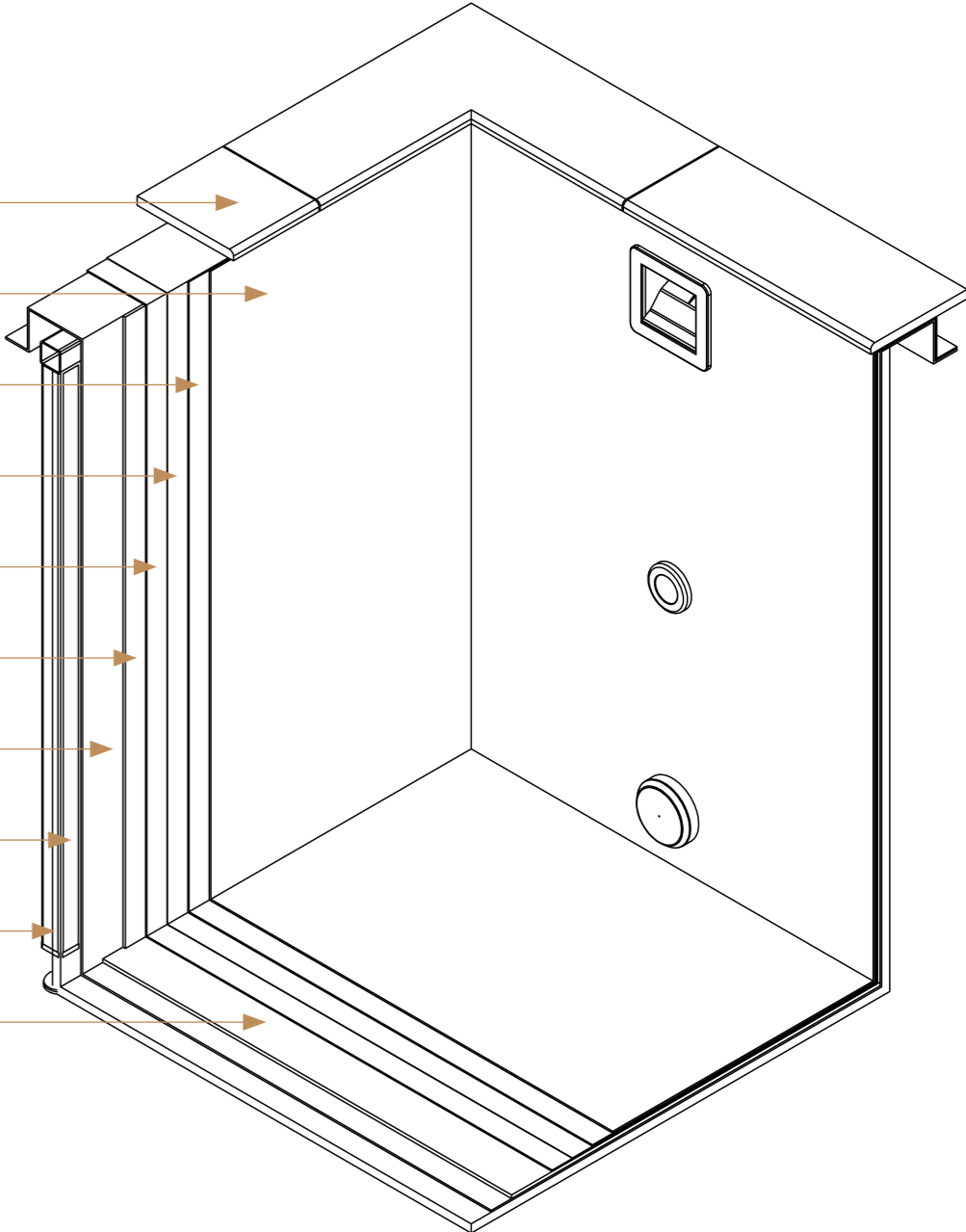

Drawings & Renders

At Centurion Leisure, upon receiving your request for a quotation, our sales team aim to return your quote as quickly as possible. Every quotation will include an associated drawing from our design team.

Further assistance can be provided for builders works and service detail to assist overall projects, should this be required. Our technical team have a vast amount of knowledge and can help where need to speed up deliverance and the completion of your project.

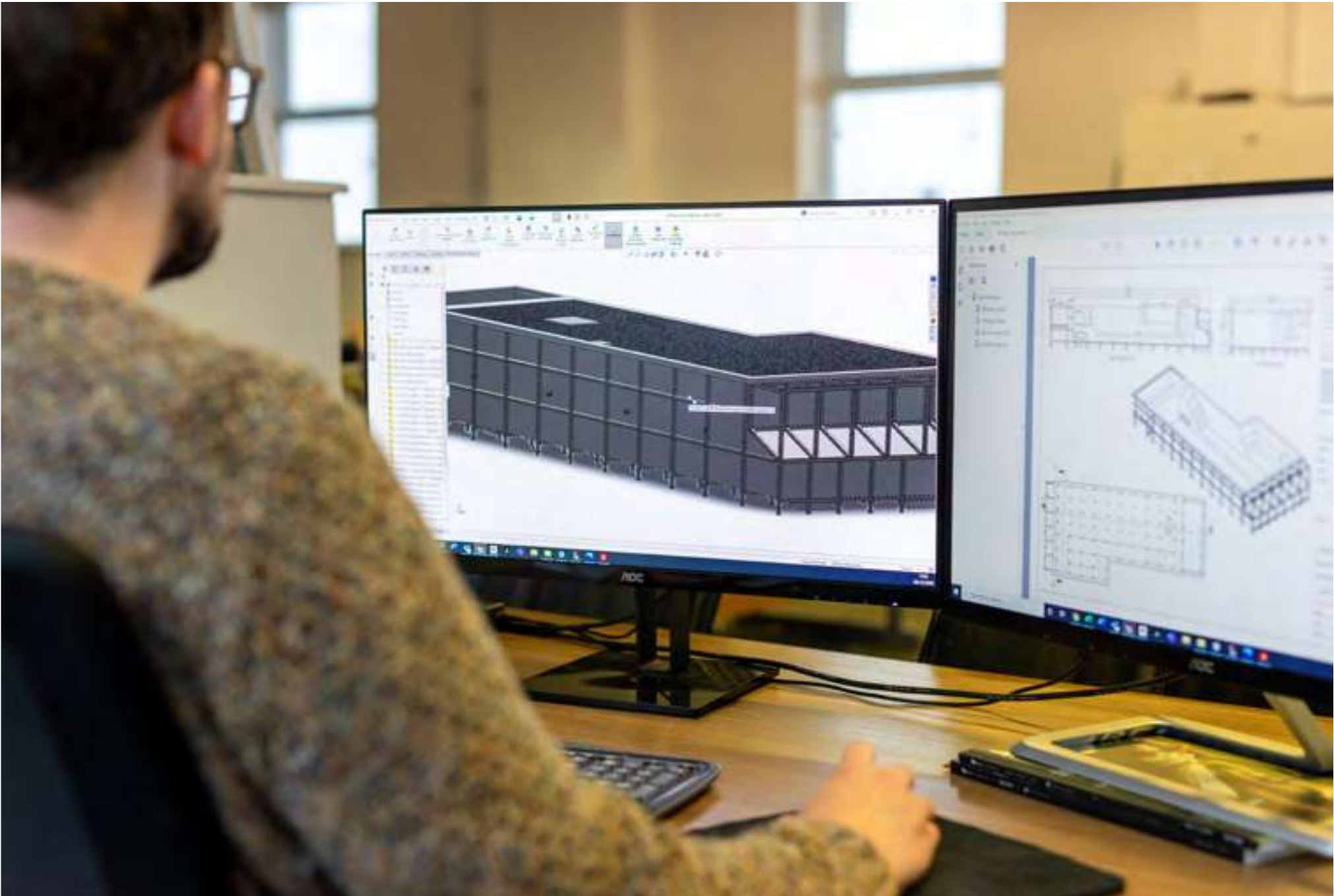
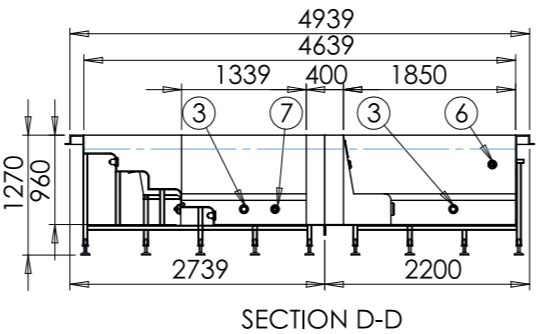
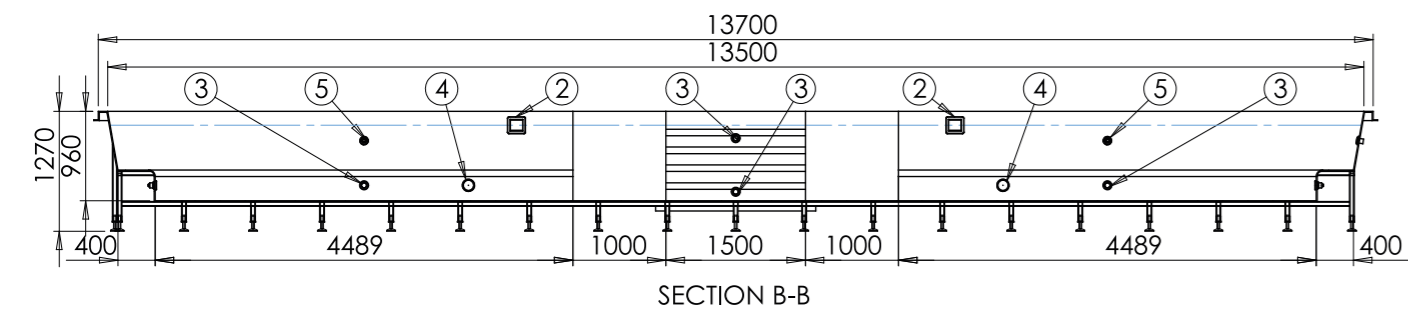
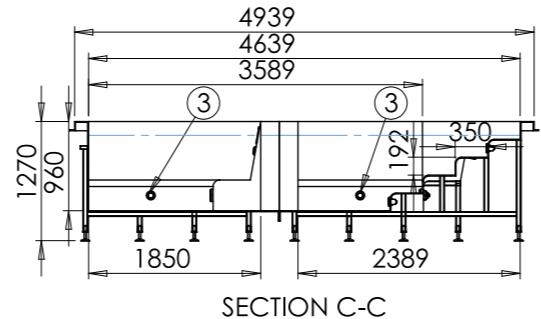
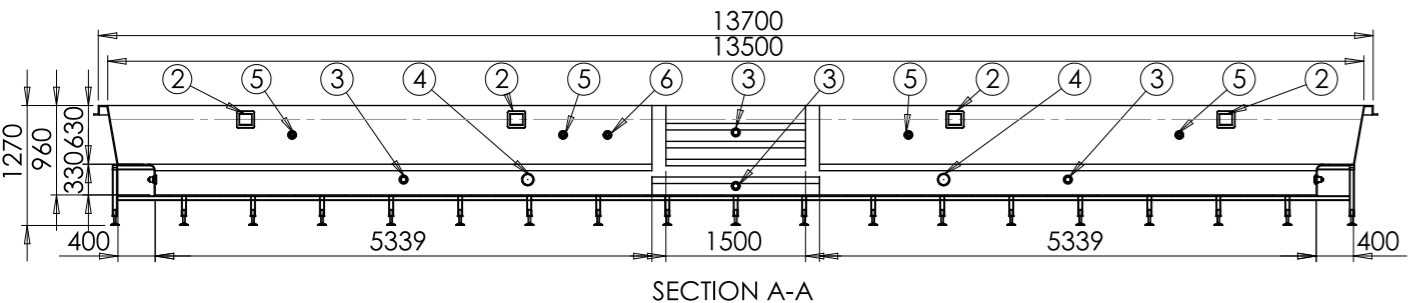

Delivery & Installation

Centurion Leisure will ensure delivery on a pre-agreed date. One of our senior engineers will always be on site to ensure a smooth and professional delivery and siting of the pool shell into place.

If your pool is required to be manufactured in multiple sections due to access restrictions on site, our team of highly skilled tilers and plumbers will complete the join once the product is in position, ready for to commission.



Warranty

All our products come with the following warranty.

- GRP shell - 10 years
- Tiling joint point (gel dot) or large format - 3 years
- Cord backed (thinner mesh/approved) - 1 year
- Paper-faced mosaic - 1 year
- Thick mesh back mosaics - No warranty
- Plumbing - 2 years
- Electrical - 1 years



Swimming Pools

Centurion Leisure offer bespoke design for all manner of pools and spas. Dependant on your needs, we can incorporate water features such as water curtains, water cannons, air and water jets. Automatic covers and upgraded grating can also be incorporated into the design.

Spas and pools can be split into multiple sections if needed, making it easier to transport and position on site if access is limited. Once on site, the sections are joined together and one of our experienced engineering teams will tile over the connecting join and complete plumbing and electrical works.

All products can be designed to be fully accessible or to sit in a bund tank should a more value engineered project be required.



Fully Accessible



Fully Accessible



Backfilled

Standard Sizes

3m Wide Pool
5m | 6m | 7m | 8m Length

3.8m Wide Pool
5m | 6m | 7m | 8m | 9m
10m | 11m | 12m Length

4.5m Wide Pool
10m | 11m | 12m Length

5m Wide Pool
10m | 11m Length



Freeboard / Skimmer Spas

In a Freeboard or Skimmer Spa, the water sits beneath the top edge of the spa or pool. This makes it a particularly good option for residential projects.



Standard Sizes

Round Skimmer

2.00m | 2.20m | 2.40m

Square Skimmer

2.00m | 2.20m | 2.40m | 2.50m

Square Skimmer with Corner Step

2.00m | 2.20m

Rectangular Skimmer Lounger

2.20m x 1.80m

Octagon Skimmer

2.25m

Oval Skimmer

2.50m x 2.00m | 3.00m x 2.00m



Deck Level / Overflow Spas

In a Deck Level/Overflow spa, the water overflows the top edge of the spa into a surrounding channel. This water is then collected in a balance tank, filtered, and returned to the spa to replace the displaced water. Deck Level/Overflow spas are ideal for commercial use.



Standard Sizes

Round Deck Level

2.00m | 2.45m | 2.50m | 3.00m
3.00m Cascading

Square Deck Level

2.50m | 3.00m

Octagon Deck Level

2.40m | 2.75m | 3.20m x 2.75m

Oval Deck Level

4.00m x 3.00m

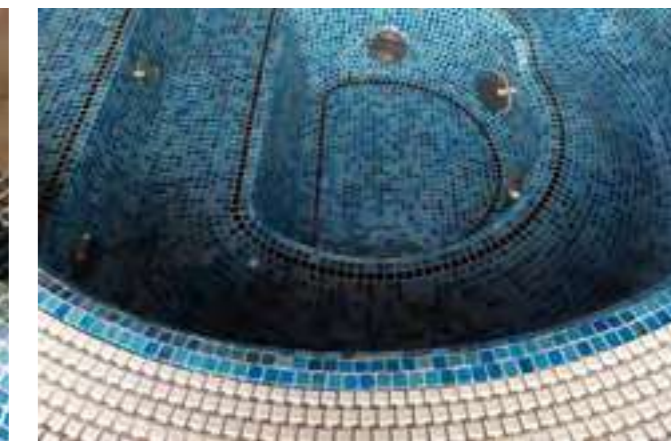

Infinity Pools & Spas

Also known as a cascading or infinity edge pool. The water cascades /waterfalls over one or all edges of the product into a lower-level channel or trough. A balance tank is required for this product.



Hydropools / Vitality Spas

Vitality or Hydrotherapy spas are designed to be relaxing, with levels allowing for standing, sitting or lounging. They are equipped with air and water jet features and can be tailored to suite your client.



Standard Sizes

Lounger Spa - Rectangular
4.00m x 3.50m

Vitality Spa - Rectangular
4.50 x 3.50m

Vitality Spa - Rectangular
5.50 x 3.50m



SwimSpas

SwimSpas can be deck level or skimmer. They use high-powered current swim jets which users can swim against continuously without the need for a full size swimming pool. SwimSpas can also be customised to have loungers and seats to create a relaxation area. The perfect pool and spa combination.



Standard Sizes

SwimSpa (Pill Shaped)

4.50m x 2.40m | 5.00m x 2.40m
5.50m x 2.40m | 6.00m x 2.40m

SwimSpa (Rectangular Shaped)

4.50m x 2.40m | 5.00m x 2.40m
5.50m x 2.40m | 6.00m x 2.40m
7.00m x 3.00m

Swimmer (Rectangular Shaped)

4.50m x 2.40m | 5.00m x 2.40m



Plunge Pools

A plunge pool is a small, typically deep pool that is usually installed in-ground, although above-ground models are available. An ideal place to cool-off after heat treatments such as a sauna or steam session or for body recovery after gym/training sessions.



Standard Sizes

Snail Shell Plunge Pool

2.00m x 2.10m

Rectangular Plunge Pool

1.80m x 1.20m

Square Plunge Pool

1.20m

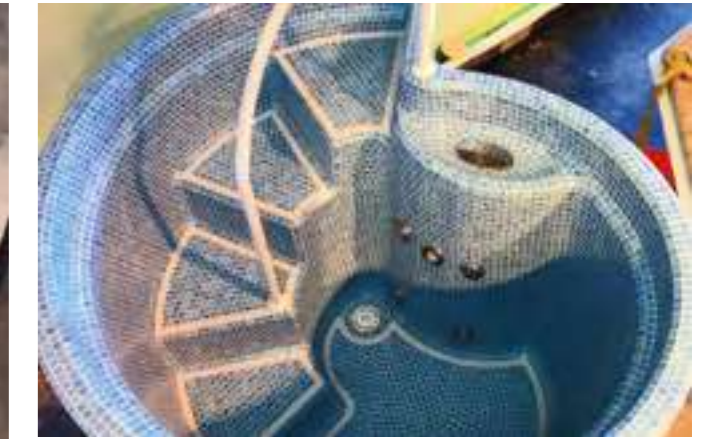

Balance Tanks

The purpose of a balance tank is to hold the water displaced by the bather or bathers. Once the bathers leave the spa, the water held in the tank then returns to the spa.

Our team can advise on the capacity your balance tank should be based on the product you have ordered.



Control Panels

Control panel features:

- To satisfy residential or commercial projects
- All control panel wiring drawings for your O&M manuals are issued prior to build
- Support from staff with 20+ years experience
- Bespoke design and setups available
- Complex panels can be created and designed collaboratively with you
- Simpler budget panels available



Additional Features

Pools and spas can be personalised in several ways. We offer demarcation tiles to enhance features such as steps, seats and loungers. Modular grating used for our deck level products can be upgraded to a colour choice that better suits your clients taste and requirements.

By request, our team can customise positions of message and air jets and to really enhance your products, we have an extensive range of water features to choose from such as water cannons and curtains.

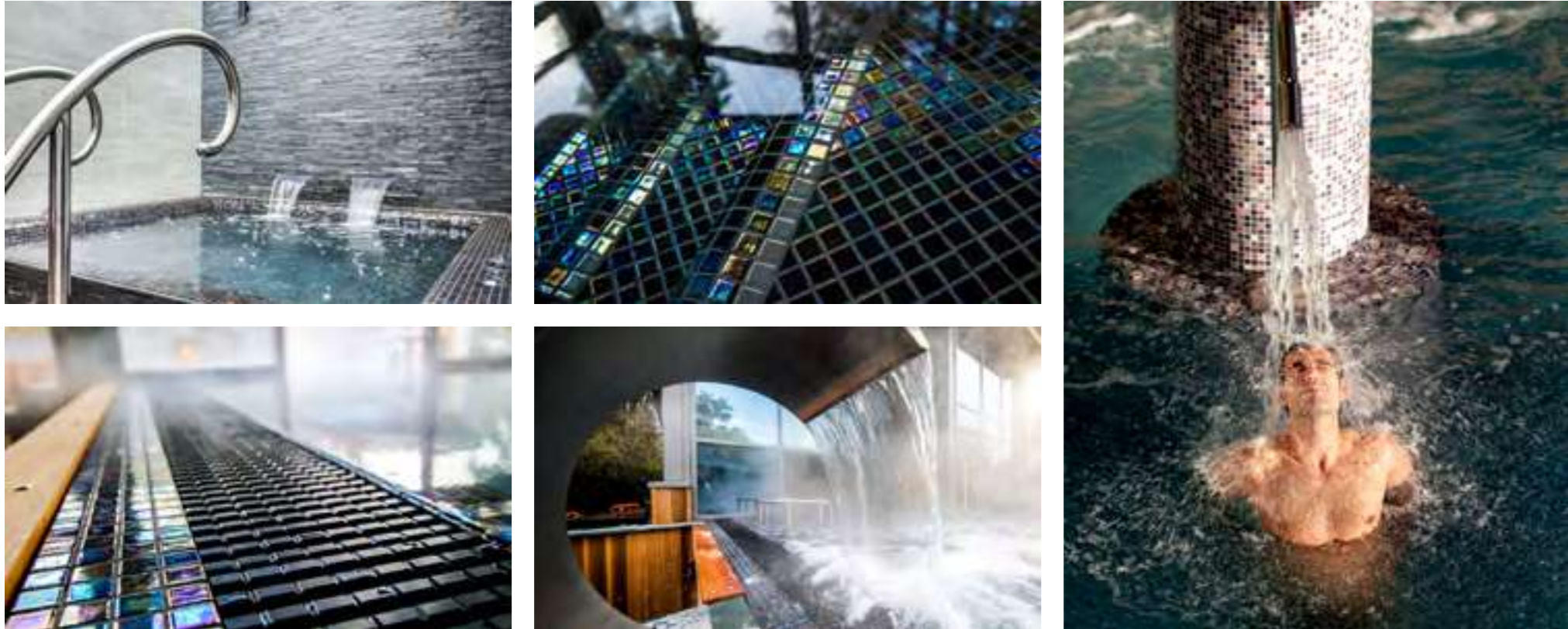

Tiles

Centurion and our team have partnered with Design Works to offer a stunning range of 25mm mosaic tiles.

All quotations include the A and A+ range, offering a huge array of colours and styles to chose from. For a look at our more extensive range of mosaic tiles, please request further information from our team.



Automatic Safety Covers

Safety is naturally a concern for those buying a pool. This type of safety cover is more capable of supporting the weight of children, pets and even adults, should they accidentally walk on it. But it also has other huge advantages over competitors' products.

Most automatic cover manufacturers use sewn webbing. With this method, the webbing often fails before the fabric does. These safety covers, however, use an exclusive, patented process to heat seal the webbing around a polymer bead and weld it to the cover in one step. This heat sealed webbing is colour matched to the fabric to create an attractive finish.

Furthermore, rather than use industry standard vinyl for the cover, which is popular with other manufacturers, these covers have the far superior Ultra Guard III vinyl composite. The high level of UV resistance offered with the Ultra Guard III will reduce the level of colour fading considerably, compared to standard vinyl, plus it offers high resistance to chlorine, acid, ozone and other pool chemicals.

The exclusive heavy duty double ball bearing pulleys have almost triple the load bearing capacity of single row pulleys used by other manufacturers. No sheer pins or bolts are used, instead the system operates with keyways to provide maximum reliability. Unlike other systems it cannot double engage causing the system to try to run in both directions at the same time, causing gears to wear and slip.

To top it all, the surrounding and connected heavy-duty frameworks and brackets are fully expandable, ensuring the most solid fixing and eliminating bent and/or broken brackets. Once the system is locked into place, it cannot move around. This safety cover is suitable for both deck mount and pit mounted installations and comes with end covers (for deck mounting) and a selection of pit coverings (for pit mounted installations).

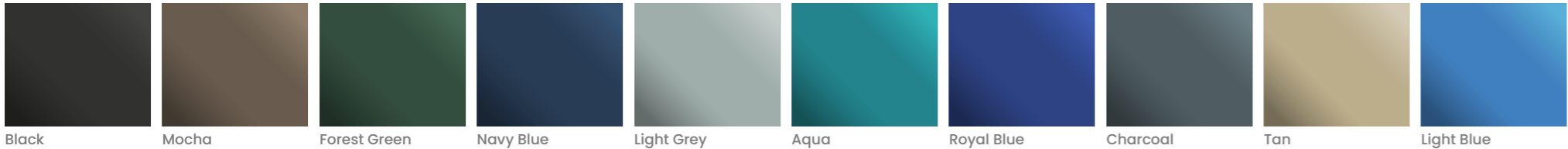

Due to limitations in the printing process the colours above may vary slightly and are for guidance only.



Automatic Slatted Pool Covers

This automatic, slatted pool cover is available for domestic and commercial pools, indoor or outdoor, and is versatile in the applications it offers.

They are the ultimate in:

- Heat insulation
- Evaporation control
- Durability
- Aesthetic appearance

The cover is manufactured in interlocking sections similar to a Venetian blind. Each section simulates the double glazing system, with 0.5" of interspace combining the highest degree of insulation with evaporation control.

The standard white sections are popular for indoor pools. On outdoor pools the solar slats with black bases promote high solar heat transfer. A distinct advantage this cover is that rain water will pass through the cover, and will not collect on top requiring removal by pump.

The roller is powered by a 24 volt motor, with remote operation from a touch screen control with built-in safety lock feature. All covers are manufactured specifically for individual pool requirements

Automatic slatted safety cover features:

- Reduces evaporation & heat loss
- Enhances the safety of the pool - safety lock available
- Minimises pool debris
- Concealed stainless steel motor driven spindle
- PVC, Polycarbonate & Foam filled slats available
- Made to measure
- In-roller motor or external motor

In roller motor system:

- No separate motor pit required
- High pressure motor vessel filled with nitrogen
- Built-in pressure sensor
- Formula 1 shock absorber seal technology
- Larger motor available for larger covers
- Simple electronic calibration
- Simple to exchange motor unit
- Simple installation for existing pools
- No risk of flooded motors



Volcano Grey



Transparent



Alu-look



Blue

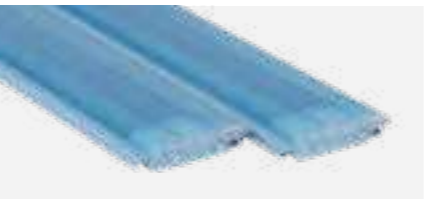

Ocean

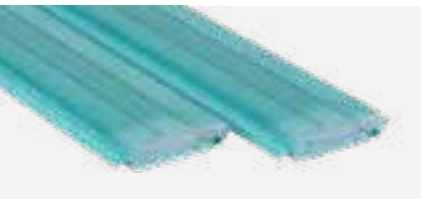

Lagoon



Crystal Clear

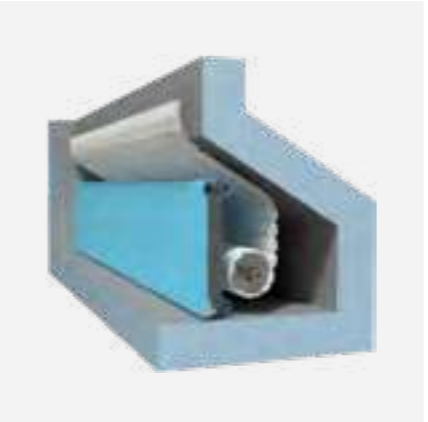

Cave with front panel



Below ground in pit & cantilever pit brackets

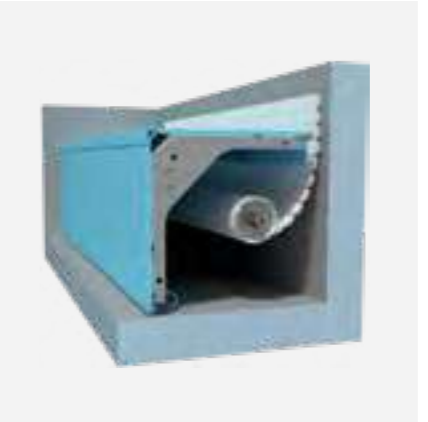

In-pool bench





D E S I G N | C O N S T R U C T I O N | I N N O V A T I O N



CENTURION LEISURE

214 High Street, Hornchurch, Essex RM12 6QP

Call us on: 01708 463 090 or 01708 620 520

Email us at: info@centurionleisure.co.uk

www.centurionleisure.co.uk

